



EMC7070 LED Application Notes

Description

This application note details how to properly handle Lightning LED's EMC 7070 LED product while using/cleaning/storage/SMT the LED in application case, in purpose of properly guiding customers and users in the application design thereof.

| | Item. | Signature | Date |
|----------|-------------|------------|------------|
| Approved | Prepared By | Zhiguo MA | 2016-11-01 |
| Process | Checked By | Tim LAN | 2016-11-09 |
| | Approved By | Donald SUN | 2016-11-11 |

Revision History

| Version | Page | Content of Change | Date |
|---------|------|--|------------|
| 1.0 | 1-18 | Preliminary Document (Application Notes) | 2016/11/01 |
| 1.1 | 1-18 | Revision on page 16 | 2016/11/09 |
| 1.2 | 1-18 | Revision on page 18 | 2016/11/11 |
| | | | |

Contents

1. Introduction

| | |
|---|---|
| 1.1 Prologue..... | 1 |
| 1.2 Application..... | 2 |
| 1.3 Dimensions | 3 |
| 1.4 Feature..... | 4 |
| 1.5 Estimation of system performance..... | 5 |

2. Characteristics

| | |
|---|----|
| 2.1 Structure..... | 6 |
| 2.2 Thermal resistance..... | 7 |
| 2.3 Forward current characteristics..... | 8 |
| 2.4 T_a vs. CIE x, y shift | 9 |
| 2.5 I_v & V_f vs. T_s Temperature characteristics | 9 |
| 2.6 Ambient temperature characteristics..... | 10 |
| 2.7 Color spectrum, $T_a = 25^\circ\text{C}$, RH60%..... | 10 |
| 2.8 Color bin pattern..... | 11 |

3. Usage and SMT guidance

| | |
|----------------------------------|----|
| 3.1 Cleaning | 12 |
| 3.2 Moisture proof packing | 12 |

| | |
|--|----|
| 3.3 Storage | 12 |
| 3.4 Soldering | 13 |
| 3.4.1 Manual soldering by soldering iron | 13 |
| 3.4.2 SMT guide | 13 |
| 3.5 Driving method..... | 16 |
| 3.6 ESD (Electrostatic Discharge)and surge current | 16 |
| 3.7 Thermal Management | 17 |
| 3.8 Risk of sulfurization and VOCs | 17 |

4. Important notes

| | |
|--------------------------|----|
| 4.1 Important Notes..... | 18 |
|--------------------------|----|

1. Introduction

1.1 Prologue

Traditional lighting source have several properties like as inexpensive, light, wide viewing angle, high color rendering index(CRI) and simple structure of space. Due to low efficiency of energy conversion, new light source is highly requested. LED is the most popular light source of the next generation. To meet these market trends, Lightning has made full line-up of EMC LED for general lighting.

Product family of middle power LED is consisting of EMC2016, EMC3014, EMC3020, which is adjust to diffuser optic solution lighting - T8 retrofit tube, flat-panel, bulb, etc. High power product family with EMC material lead frame is consisting of EMC3030, EMC5050, EMC7070, EMC1A1A which is powerful solution for directional illumination - MR, PAR, Torch, Street light, etc., together with 2nd optical Lens solution. EMC product family covered power rating from 0.2W~20W, can completely fulfill all kinds of application in general lighting applications.

This application note is focused on EMC7070 which is very powerful solution for directional illumination and adopted advanced techniques such as low thermal resistance and good uv resistance and EMC packaging technology. Detail information, characteristics, performances and useful guidance of EMC7070 are written on this note. Please be noted all data and graphs are made for designer reference only, not for any guarantee. Thus it could be changeable without any pre-notification.

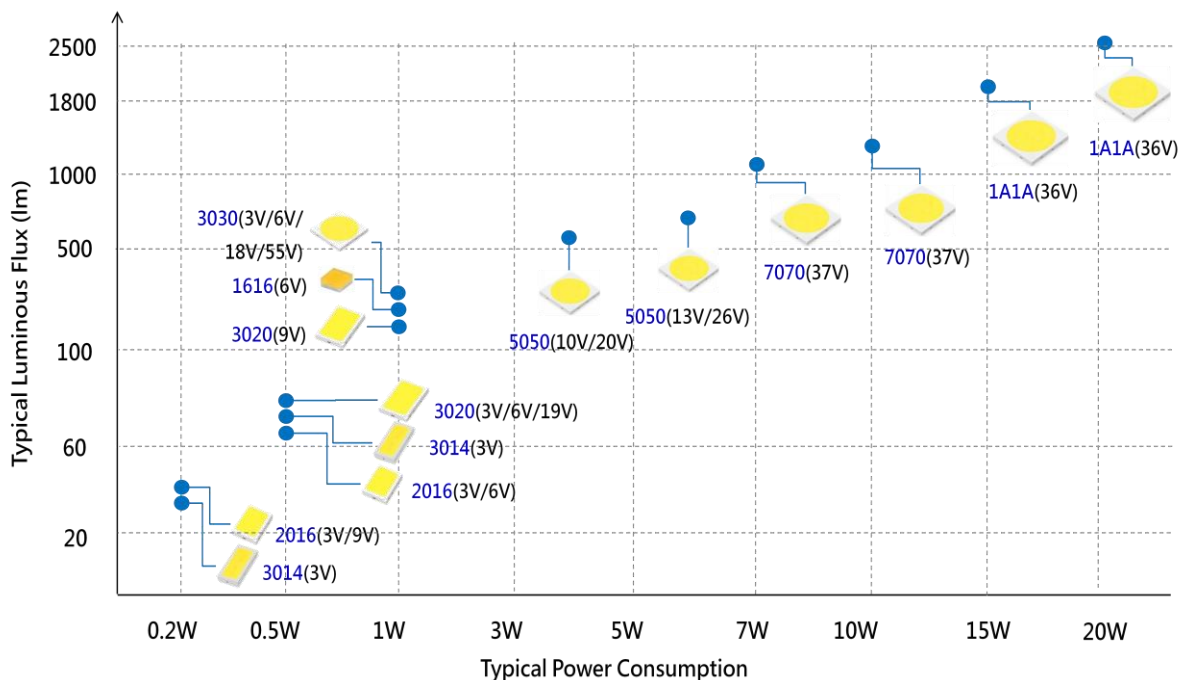















Lightning EMC LED series for illumination

1. Introduction

1.2 Application

EMC7070 is the most optimal solution for directional application which require small form factor making easy design to target beam angle and high luminous output including robust reliability. High density of light emitting surface will help designer to match datasheet value with final results of illumination at real operating condition. It can fully replace COB with high reliability and even production efficiency. Applications are listed below (but not restricted)

- Consumer – Torch light EMC7070 is convenient light source to collect beam to spot area through reflector. LED structure is suitable for reducing yellow ring effect.
- Indoor – MR, PAR, Down light, Spot light One of the major market trend of LED is low-cost. Middle power LED is advantageous in these needs. But there are some barriers to design target beam angle due to large amount of LEDs rather than high power LED. For these reason, EMC7070 is optimal solution for low-cost and easy to design directional illumination.
- Outdoor – Street Light, Security light, Tunnel light, Parking light . High flux and efficacy help designer to make superior outdoor illumination.
- Industry – High bay, Low bay

| Application | |  |  |  |  |  |  |  |  |  |  |  |  |  |  |  |
|-------------|-------------|---|---|---|---|---|---|---|---|--|---|---|---|---|---|---|
| | | Tube | Bulb | Candle lamp | Panel light | Down light | Spot light | PAR lamp | Ceil lamp | Street light | Proje ction | High bay | Car light | Flash light | Wall lamp | Stage |
| 0.2W | EMC2016 | ● | ● | ● | ● | | | | | | | | ● | | | |
| | EMC3014 | ● | ● | ● | ● | | | | | | | | | | | |
| 0.5W | EMC3020 | ● | ● | | ● | ● | | | | | | | | | | |
| | EMC3014 | ● | ● | ● | ● | | | | | | | | | | | |
| 1W | EMC3020 | | ● | | ● | ● | | | | | | | | | | |
| | EMC3030 | | ● | | | ● | ● | ● | ● | ● | ● | ● | ● | | | |
| | Cube1616 | | ● | | | ● | | | | | | | | ● | | |
| 1-5W | Ceramic3535 | | | | | | ● | ● | ● | ● | ● | ● | ● | | ● | ● |
| 4-6W | EMC5050 | | | ● | | ● | ● | ● | | ● | ● | ● | | | | |
| 7-10W | EMC7070 | | ● | ● | | ● | ● | ● | | ● | ● | ● | | | | |
| 15-20W | EMC1A1A | | | | | ● | ● | ● | | | ● | ● | | | | |

Product application address

1. Introduction

1.3 Dimensions



[Top view]

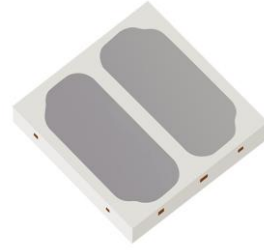

[Back view]

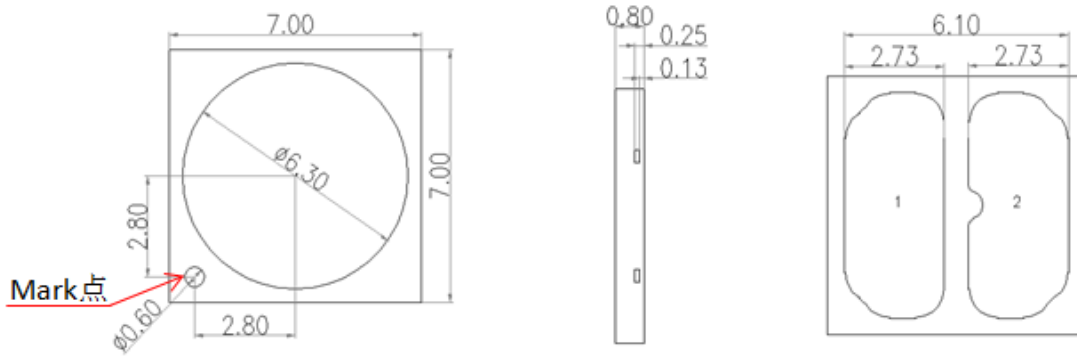

[Product drawing]

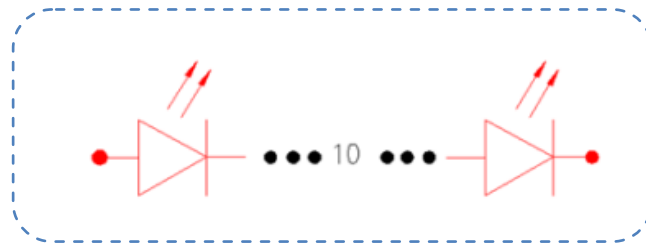

Electrical circuit diagram [12S1P]

| EMC series | Circuit of chips | $V_F(V)$ | $I_F(mA)$ | Rated power(W) | Flux(lm) @3000K | Efficacy (lm/W) |
|------------|------------------|----------|-----------|----------------|-----------------|-----------------|
| EMC7070 | 16S1P | 50 | 120 | 6 | 747 | 125 |
| | 22S1P | 68.6 | 120 | 8 | 965 | 117 |
| | 30S1P | 93.4 | 120 | 11 | 1316 | 117 |
| | 12S1P | 37 | 200 | 8 | 906 | 122 |
| | 12S2P | 37.9 | 280 | 11 | 1239 | 116 |

[Provide the same package with different VF and different power]

1. Introduction

1.4 Feature

- ◇ **Dimension: 7.0x7.0x0.8mm, LES area: Φ 6.3mm**
- ◇ **Thermally Enhanced EMC Package Design**
- ◇ **High Power, up to 14W**
- ◇ **Max. Driving Current 240mA for 12S1P circuit diagram**
- ◇ **High Color Quality with CRI Min. 80, CRT 90 or CRT 95 as well**
- ◇ **Pb-free Reflow Soldering Application**
- ◇ **Max junction temperature 125 deg.**
- ◇ **Lm-80 test qualified**

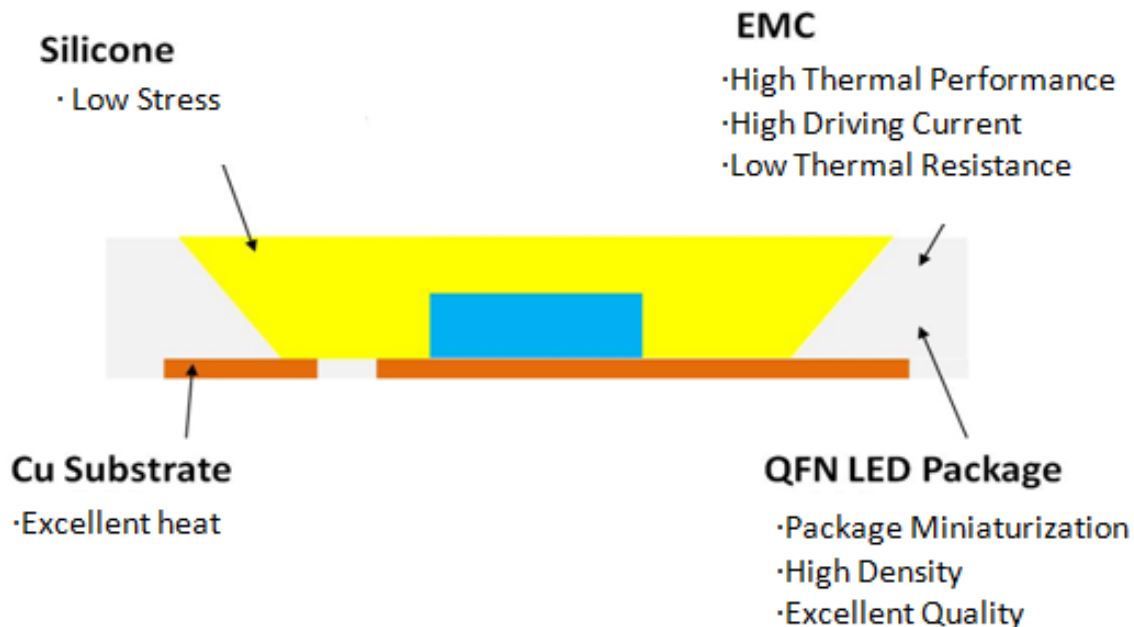

EMC7070 is built by Epoxy Molding Compound materials and Cu substrate, via molding technology to form lead frame. Cu substrate with Ag plating mainly aim to increase reflection and get more luminous flux and could help to reduce yellow ring phenomenon.

EMC material is the optimum material having fast heat transfer characteristic, reliability, design freedom of electrical pad space and dielectric behaviors.

To progress optic design (lens, reflector, etc.), designer could get optics raw-file of EMC7070 from webpage below:

<http://pan.baidu.com/s/1i5HaEW1>

(LightTools, TracePro, RS8).

2.Characteristics

1.5 Estimation of system performance

When designer start to develop a lamp/luminaries, the most important thing is to choose the LED with which the electrical and optical characteristics, reliability and the resulted performance estimation of final lumen output is fitted for design target. Indeed estimation of system performance is quite necessary to forecast the range of mass production and these kinds of estimation are closely related with the ability of LED supplying which consists of luminous flux rank, forward voltage bin and color chromaticity bin.

For instance, in case of a certain system condition such as 90% power supply conversion efficiency and 92% optic transmission efficiency, the output performance of illumination could be estimated by the number of LEDs, with forecasted Ts value and driven forward current. The expected performance range of mass production is depends on the combination of fine flux rank and voltage binning. Worst case of poor performance could be made by the combination of high voltage bin and low flux rank. **At 5700K CCT as below sheet , 9 LEDs and 220mA driving current per LED, the combination of HE middle flux rank and voltage binning 38~39V could be expected to make 7339lm luminous output, 80.0W total power consumption and 91.67lm/W of efficiency.** The best performance could be made by HG rank and minimum voltage bin at same CCT and operating condition. Depending on which rank and binning is used, the output performance could vary. Designer should consider these relations to expect product yield of final set. So it is a essential for a designer to make a LED solution with right flux rank and voltage binning according to the final product requirements.

| Assumption | | Product requirement | |
|--|--------------|---------------------|-------------|
| Optical efficiency | 92.0% | | |
| Electrical efficiency (voltage>50V) | 90.0% | Power(W) | 80(±5%) |
| Electrical efficiency (voltage<50V) | 85.0% | Flux(lm) | 7200(±10%) |
| Ts forecast(°C) | 95 | CCT(K) | 5700 |
| Ripple | 50.0% | CRI | ≥80 |

[Flood light requirement input]

| LED | VF (V) | IF (mA) | P (W) | Flux @Operate Current (Lm) | Flux @Ts forecast (Lm) | Flux @optical loss(Lm) | LED num. (pcs) | Stable flux (Lm) Ts<95°C | Lamp power (W) | Lamp eff. (Lm/W) |
|------|-----------|------------|-------|-------------------------------------|------------------------------|------------------------------|----------------------|--------------------------------|----------------------|------------------------|
| 7070 | 37.2 | 220 | 8.18 | 1040 | 915.2 | 823.68 | 9 | 7338.99 | 80.06 | 91.67 |

[LED solution of 80W flood light at CCT 5700K]

2.Characteristics

2.1 Structure

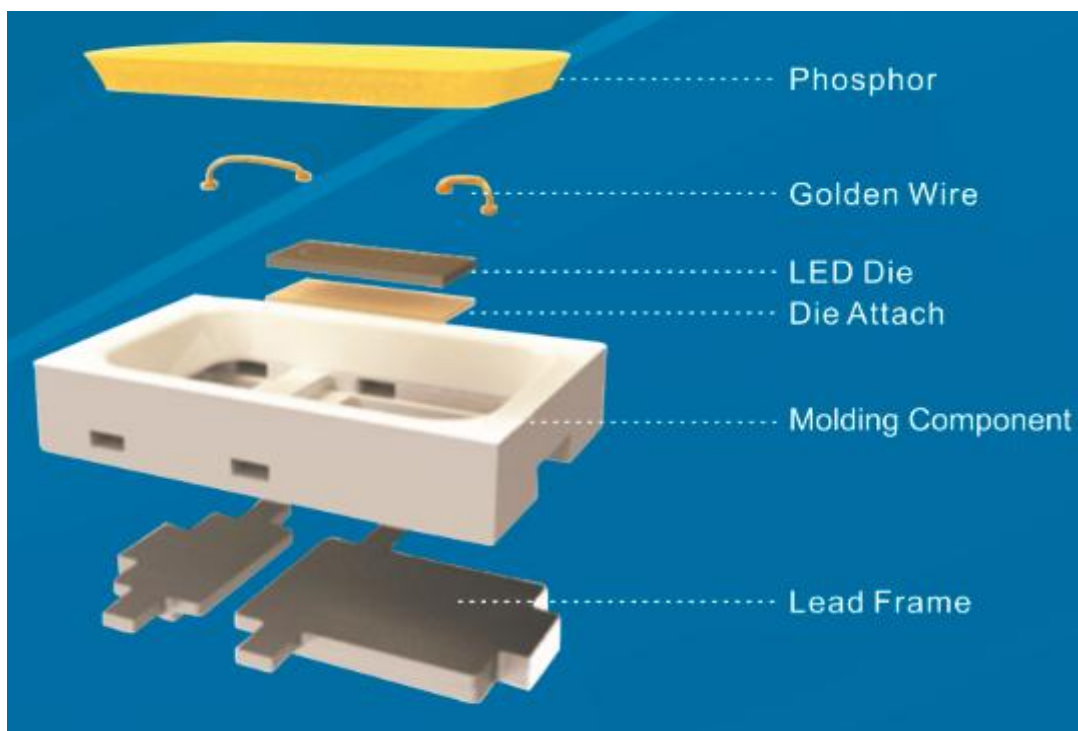

[Explosion view of EMC LED package]

EMC7070 is made of phosphor, golden wire, chip, die attach, EMC and substrate. Dynamic operating parameters related to the thermal, optical and electrical properties are forward current, voltage, thermal resistance, junction temperature, phosphor performance, which is major unique characteristics of LED as well.

From these complex relation, LED sweep curves doesn't have simple linear properties. In this application note, more detail sweep curves which is VF vs IF, Flux vs IF etc. are presented as in the following pages, and surely main curves are based on datasheet.

In fact, designer can easily measure T_s which is solder temperature on PCB instead of T_j . Between T_j and T_s surely some differences of electrical and thermal characteristics could be happened due to electrical and thermal resistance existing. For example, let's assume 800lm at T_j 85 °C on datasheet; then 800lm should be recognized as the same as lower T_s temperature including thermal resistance ($R_{th\ j-s}$) is achieved. If you want to know the relation between T_s and T_j and want to get T_j value, please refer to the next page.

T_s point

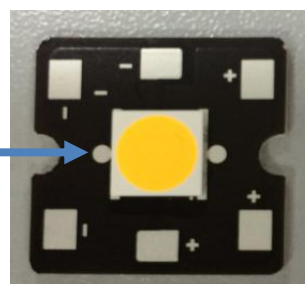

2.Characteristics

2.2 Thermal resistance

Normally thermal resistance (R_{th}) of LED package could be variable depending on temperature and current. Especially high power LED (normally over 1watt power consumption) has wider deviation range of thermal resistance rather than middle power or small power LED. This effect is caused by the difference of thermal density and current density versus fixed physical dimension.

Thermal resistance (R_{th}) could be defined variously as like $R_{th}(j-s)$, $R_{th}(j-a)$, $R_{th}(s-c)$ etc., $R_{th}(j-s)$ is R_{th} from LED chip junction to solder point on PCB, $R_{th}(j-a)$ is junction to ambient. Normally $R_{th}(j-a)$ is called as thermal resistance of system.

For thermal details, see another separated TDLED's technical article named of "Thermal Management of the EMC LED"

T_j (temperature of LED junction)

= T_s (temperature of solder) + $R_{th}(j-s)$ X power consumption of LED

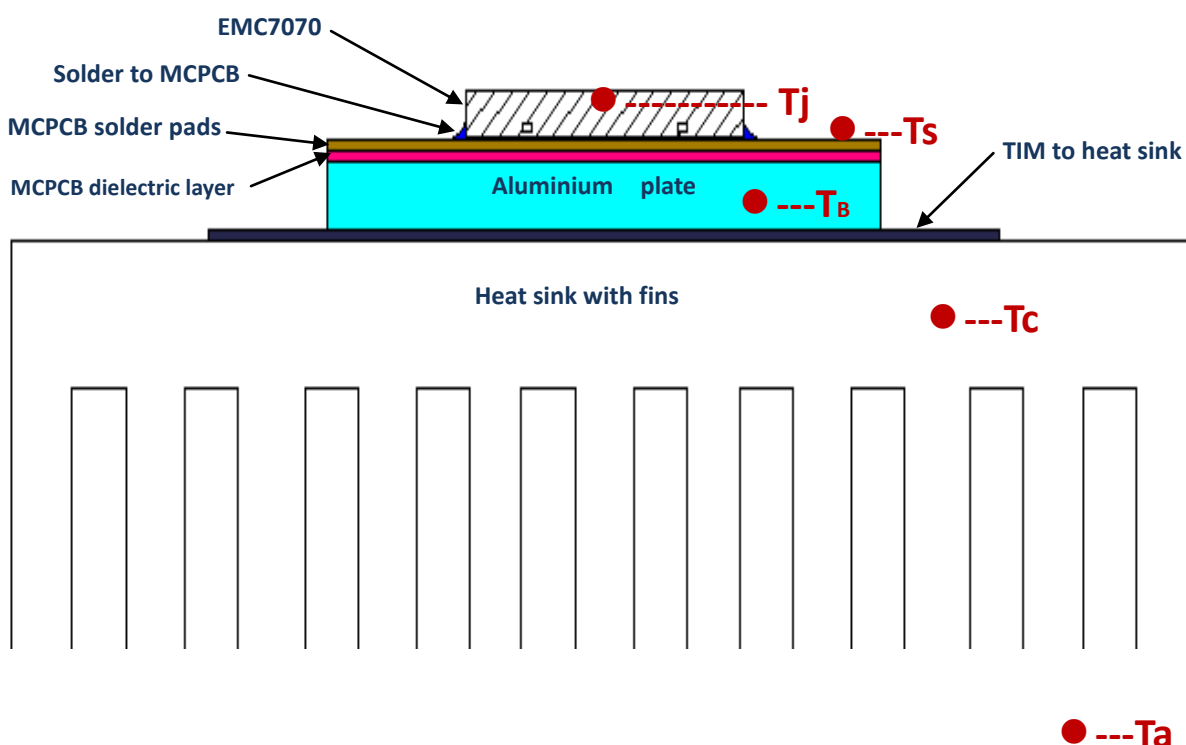

Lightning can provide $R_{th}(j-s)$ test report at different temperature with different forward current. You can check LED's $R_{th}(j-s)$ from its datasheet for reference.

2.Characteristics

2.3 Forward current characteristics

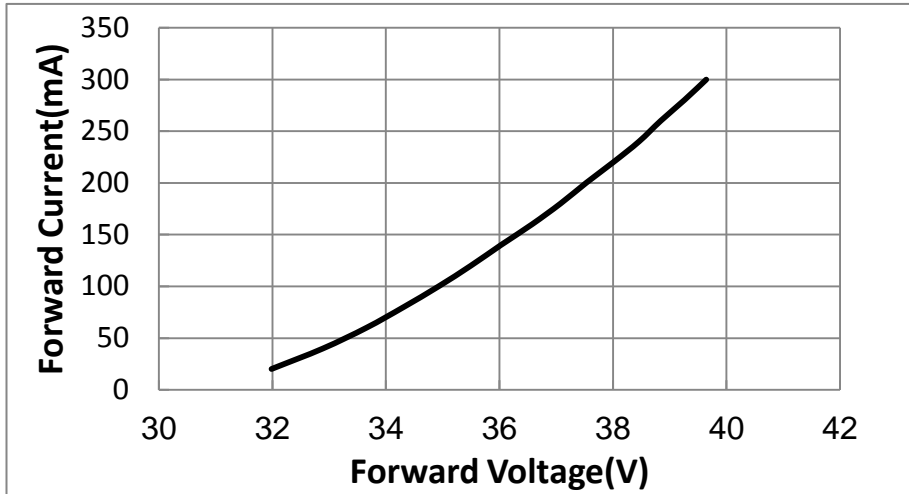

[Forward Voltage vs. Forward Current ward, Ta = 25°C]

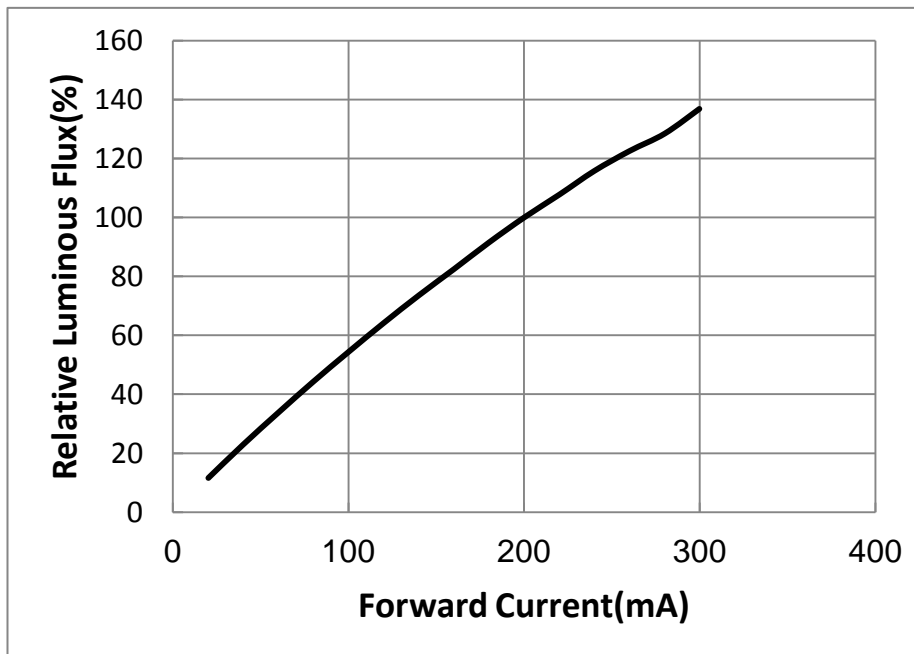

[IF---Relative Luminous flux , Ta = 25°C]

2.Characteristics

2.4 Ta vs. CIE x, y shift

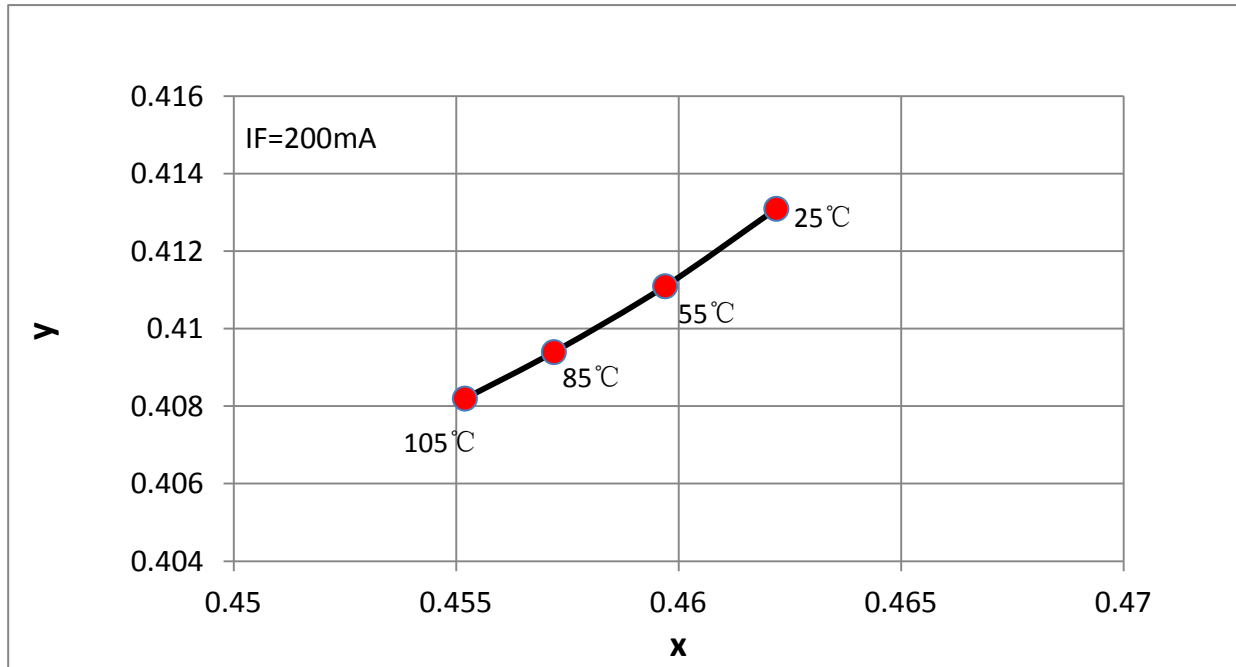

[Ta vs. CIE x, y Shift]

2.5 Iv & Vf vs. Ts Temperature characteristics

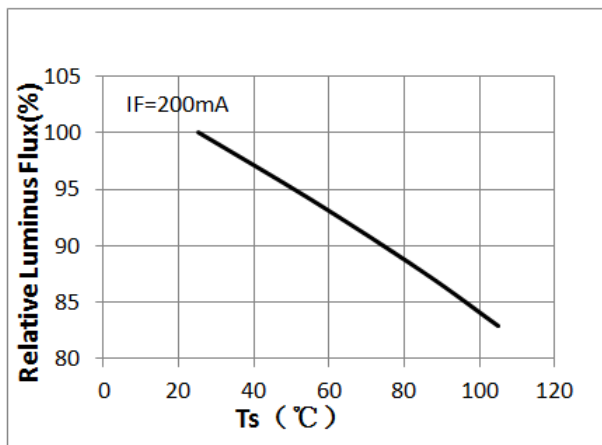

[Ts—Relative Luminous flux]

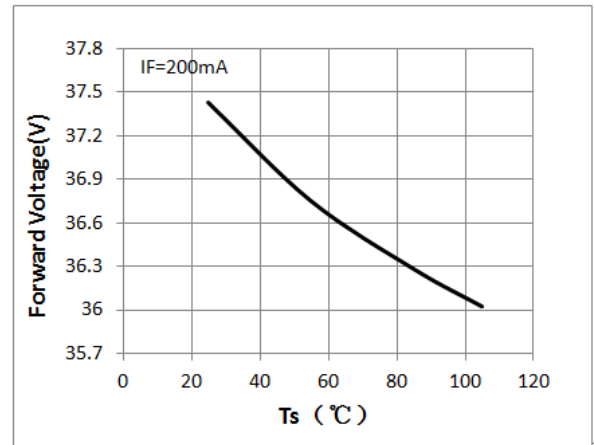

[Ts—Forward Voltage]

2.Characteristics

2.6 Ambient temperature characteristics

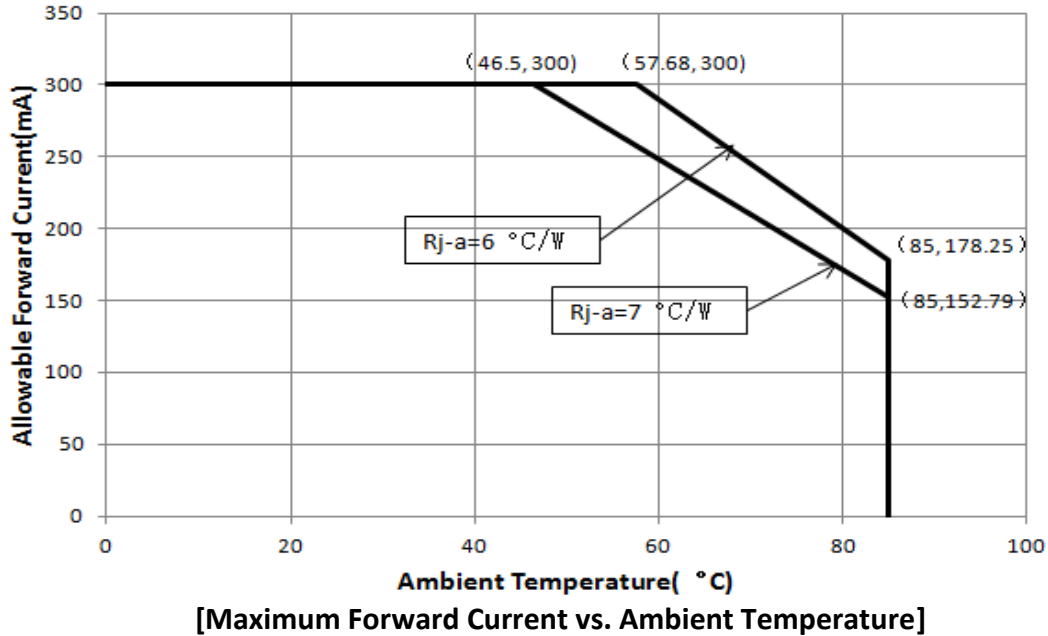

2.7 Color spectrum, Ta = 25°C, RH60%

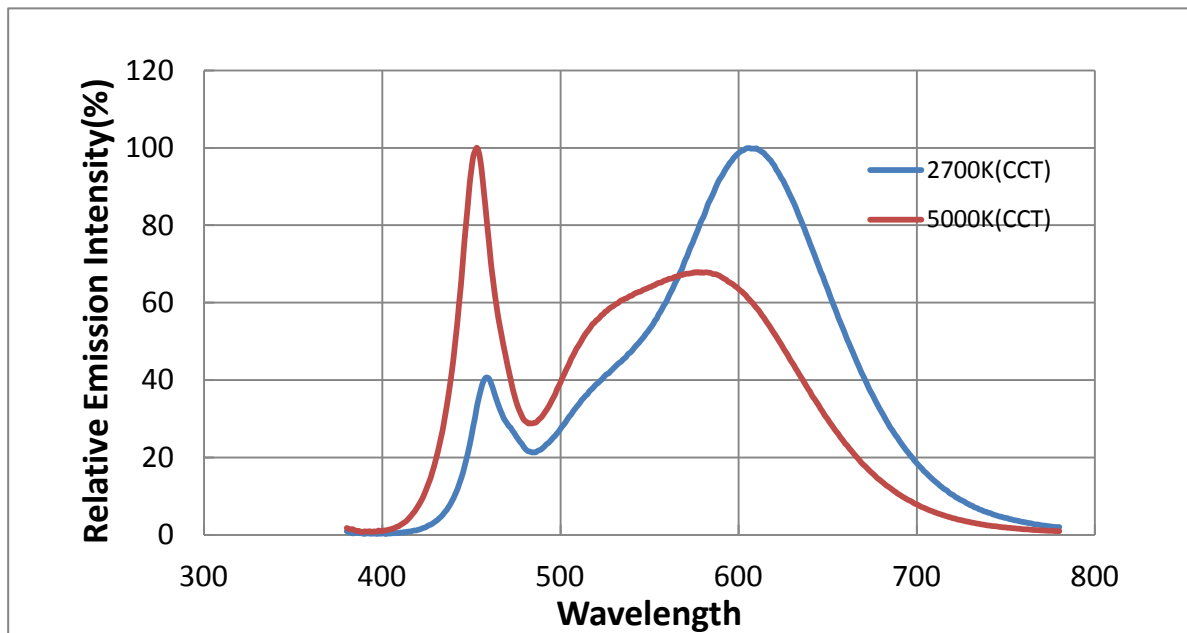

2.Characteristics

2.8 Color bin pattern

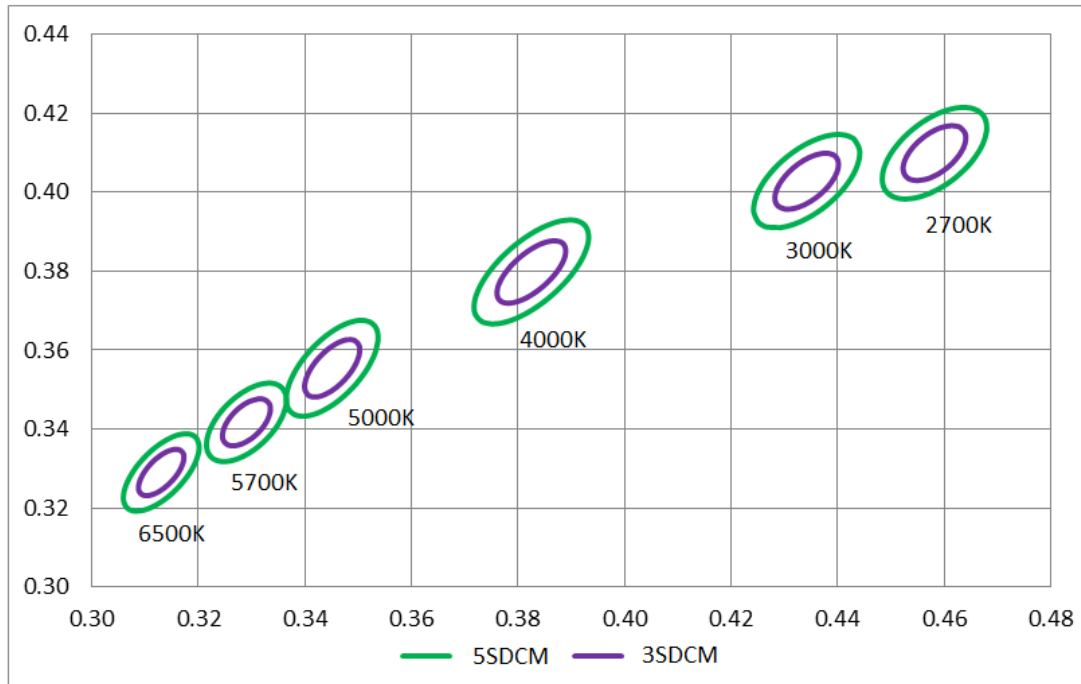

[5 SDCM and 3 SDCM color temperature range]

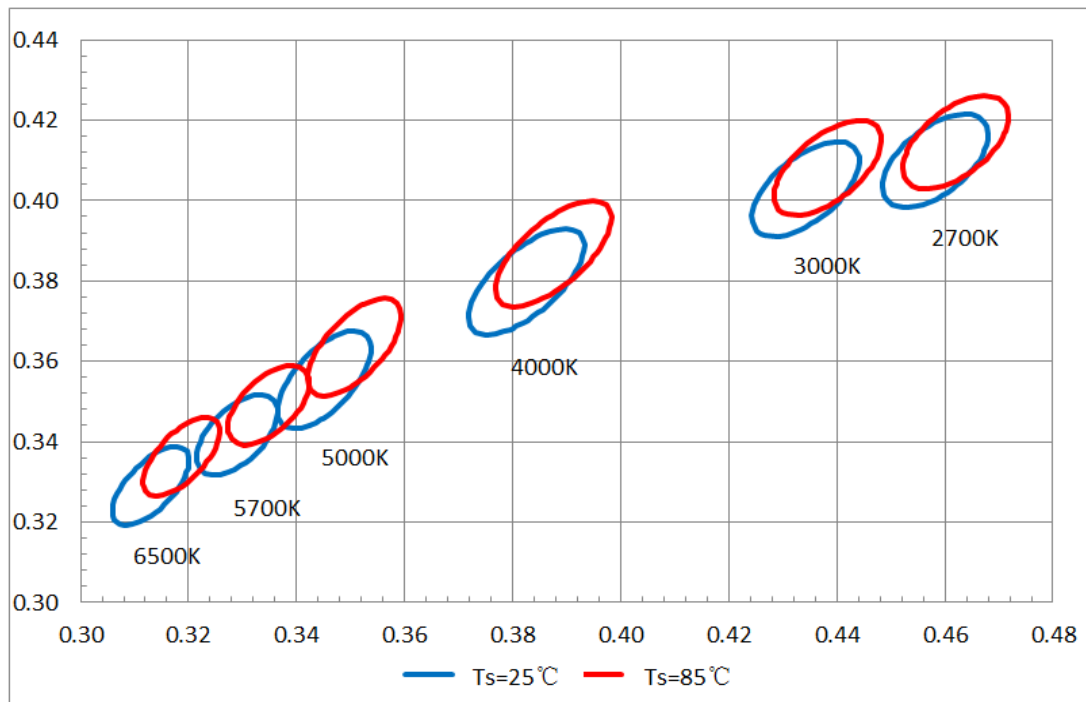

[Hot binning service]

3.Usage and SMT guidance

3.1 Cleaning

Don't use unspecified chemical liquids to clean the EMC LED, the chemical could harm the LED. When washing is necessary, IPA is recommended to use. Please be noted if immerse the EMC LED in alcohol at room temperature for less than 1 minute, please dry it at room temperature for 15 minutes before use.

The influence of ultrasonic cleaning on the EMC LED depending on factors such as ultrasonic power and the way EMC LED are mounted. Ultrasonic cleaning shall be pre-qualified to ensure this will not cause damage to the LED.

3.2 Moisture proof packing

In order to prevent moisture absorption into EMC LED during the transportation and storage, the LED is packed in a moisture-barrier bag. Desiccants and a humidity indicator are packed together with the LED as the secondary protection. The indication of humidity indicator card provides the information of humidity within the packing.

3.3 Storage

The EMC LED product is qualified as Moisture Sensitive Level 3 per JEDEC J-STD-020D Precaution when handling this moisture sensitive product is important to ensure the reliability of the product .Shelf life in original sealed bag at storage condition of <30°C and <90%RH is 12 months. Baking is required whenever shelf life is expired.

Before opening the package, please check whether the bag leak air or not.

After bag opening, the EMC LED must be stored under the condition < 30°C and < 60%RH. Under this condition, the LED must be used (subject to reflow) within 24 hours after bag opening, and re-baking is required when exceeding 24 hours.

For baking, place EMC LED in the oven at temperature of 60°C and relative humidity ≤10%RH, for 10- 24 hours.

Take out the material from packaging bag for re-bake. Do not open the door of oven frequently during the baking process.

3.Usage and SMT guidance

3.4 Soldering

3.4.1 Manual soldering by soldering iron

The use of a soldering iron of less than 25W is recommended and the temperature of the iron must be kept at below 315°C, with soldering time within 2 seconds.

The epoxy resin of the EMC LED should not be in contact with tip of soldering iron.

No mechanical stress should be exerted on the resin portion of the LED during soldering.

Handling of EMC LED should be done when the package has been cooled down to below 40°C or less. This is to prevent the EMC LED failures due to thermal-mechanical stress during the process.

3.4.2 SMT guide

Recommended solder pad design for SMT (EMC T7C Series -7070)

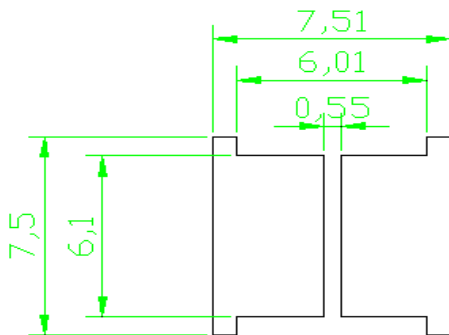

☐ ☐

Recommended solder pad

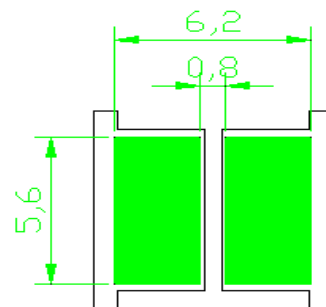

Recommended stencil opening

Recommended Stencil Thickness: 0.08 - 0.1mm

Lightning could provide *.pcb File to customers upon request

3.Usage and SMT guidance



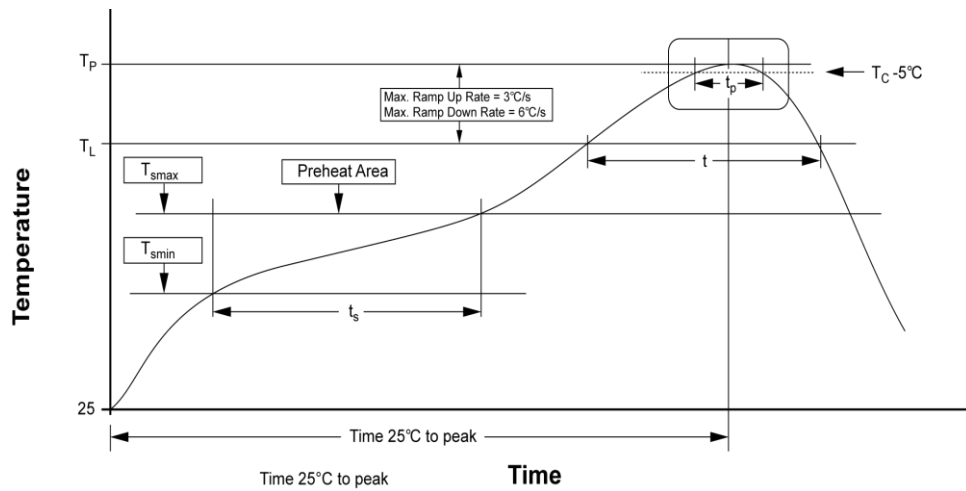





Recommended reflow profile for Pb-Free process (Acc. to J-STD-020D):



| Parameters | Pb-Free Assembly |
|------------------------------------|------------------|
| Tsmin | 150 °C |
| Tsmax | 200 °C |
| ts(preheat from Tsmin to Tsmax) | 60-120 s |
| Average Ramp Up Rate (Tsmax to Tp) | <3 °C/s |
| TL | 217 °C |
| Time Duration within TL (t) | 60-150 s |
| Tp | 260 °C |
| Time Duration within Tp±5°C(tp) | < 10 s |
| Average Ramp Down Rate (TptoTsmin) | <6 °C/s |
| Time 25°C to peak | < 8 min |

3.Usage and SMT guidance

☑ The nozzle of pick-up EMC7070 recommended:

| Type | CN020 (Option) | CN030 (Option) | CN040 | CN065 | CN140 | CN220 | CN400N | CN750 | CN110 |
|--------|---|---|---|---|---|---|---|---|---|
| Shape |  |  |  |  |  |  |  |  |  |
| OD(mm) | φ0.5 | φ0.6 | φ0.75 | φ1.2 | φ2.2 | φ3.6 | φ6.2 | φ9.0 | φ12.7 |
| ID(mm) | φ0.16 | φ0.28 | φ0.38 | φ0.65 | φ1.4 | φ2.2 | φ4.0 | φ7.5 | φ11.0 |







Outer diameter : 5.5~6.2mm

Inner diameter : 2.8~4.0mm

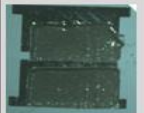
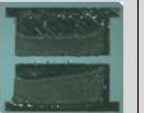
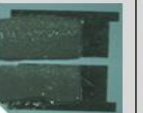
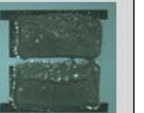
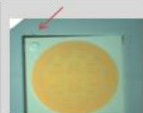
There is a series of nozzles equipped for each brand of SMT machine from its supplier. SMT machine suppliers such as Samsung, YAMAHA, Panasonic, etc...whose nozzle can be purchased in market, also you can customize nozzle if you need for a special component with which the existing nozzle was not able to pick up. Because our LED material is EMC, please take care while suction from nozzle, don't break LED during SMT pick-up process. Make sure all of LEDs are located on proper position of MCPCB after SMT. Some common failure examples as shown below, please make sure that will not take place in your SMT process.

Samsung CN400N



| | | | | | |
|--------------|---|--|---|---|---|
| Solder Mark |  |  |  |  |  |
| | Ok | Miss-align | Solder-lack | Solder-incline | Thick-solder |
| Pick & Place |  |  |  |  | |
| | Ok | Fault-cathode | Fault-cathode | Miss-place | |
| After reflow |  |  | | | |
| | Ok | Solder-ball | | | |

[Samsung nozzle]

[Some failure examples in SMT process]

3.Usage and SMT guidance

3.5 Driving method

When designing a circuit, the current through each LED must not exceed the Absolute Maximum Ratings. LED is a constant-current driving device. In case of operating at a constant voltage, Circuit B is recommended, that is to say, it is recommended that a current limiting resistor be incorporated in the driving circuit, in series with each LED as shown in Circuit B; if using Circuit A, the current through the LEDs may vary due to the variation in forward voltage characteristics of the LEDs.

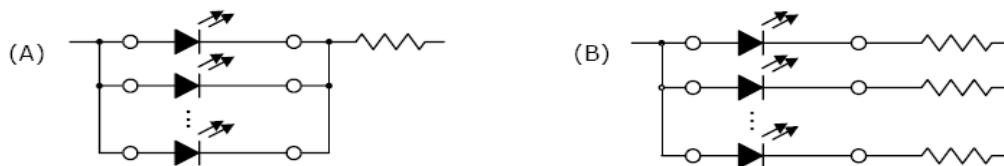

3.6 ESD (Electrostatic Discharge)and surge current

Electrostatic discharge (ESD) or surge current (EOS) may damage SMD LED.

Precautions such as ESD wrist strap, ESD shoe strap or antistatic gloves must be worn whenever handling of the EMC LED.

Suggestions to prevent ESD damage:

- Use of a conductive wrist band or anti-electrostatic glove when handling these LEDs.
- All devices, equipment, and machinery must be properly grounded.
- Work tables, storage racks, etc. should be properly grounded.
- Use ion blower to neutralize the static charge which might have built up on surface of the LED's plastic lens as a result of friction between LEDs during storage and handling.
- It is recommended to perform electrical test to screen out ESD failures at final inspection.

ESD-damaged LEDs will exhibit abnormal characteristics such as high reverse leakage current, low forward voltage, or "no light up" at low currents .To verify for ESD damage, check for "light up" and Vf of the suspected LEDs at low current .The Vf of "good" LEDs should be >2.0V@0.1mA for InGaN product and >1.4V@0.1mA for AllnGaP product.

3.Usage and SMT guidance

3.7 Thermal Management

Thermal management of the EMC LED must be taken into consideration during the design stage of the LED application. The current should be de-rated appropriately by referring to the de-rating curve attached on each product datasheet.

*For details, see another separated TDLED's technical article named of **"Thermal Management of the EMC LED"**.*

3.8 Risk of sulfurization and VOCs

Risk of sulfurization (or Tarnishing)The LED from LIGHTNING uses a silver-plated lead frame and its surface color may change to black(or dark colored) when it is exposed to sulfur(S), chlorine (Cl) or other halogen compound. Sulfurization of lead frame may cause intensity degradation, change of chromaticity coordinates and, in extreme cases, open circuit. It requires caution. Due to possible sulfurization of lead frame, LED should not be used and stored together with oxidizing substances made of materials in the following list: Rubber, plain paper, lead solder cream and so on.

VOCs (volatile organic compounds) can be generated from adhesives, flux, hardener or organic additives used in luminaries (fixtures). Transparent LED silicone encapsulant is permeable to those chemicals and they may lead a discoloration of encapsulant when they expose to heat or light. This phenomenon can cause a significant loss of light emitted(output) from the luminaries (fixtures). In order to prevent these problems, we recommend you to know the physical properties of the materials used in luminaries, They must be selected carefully.

4. Important Notes

4.1 Important Notes

- Some packaging sizes of the EMC LED products are very small and the resin is still soft after solidification. Users are required to handle with care, never touch the resin surface of the LED products.
- To avoid damaging the products surface and interior device, it is recommended to choose proper Nozzle to pick up EMC LED products during the process of SMT production. If handling is necessary, it should take more careful to pick up these products. For Small EMC series, it is recommended to use rubber material tweezers to pick up the products.
- Please handle with care after reflow because EMC material is fragile, don't put MCPCBs pile-up after reflow
- Some picture as below show you how to handle MCPCB with LEDs after reflow for your reference:

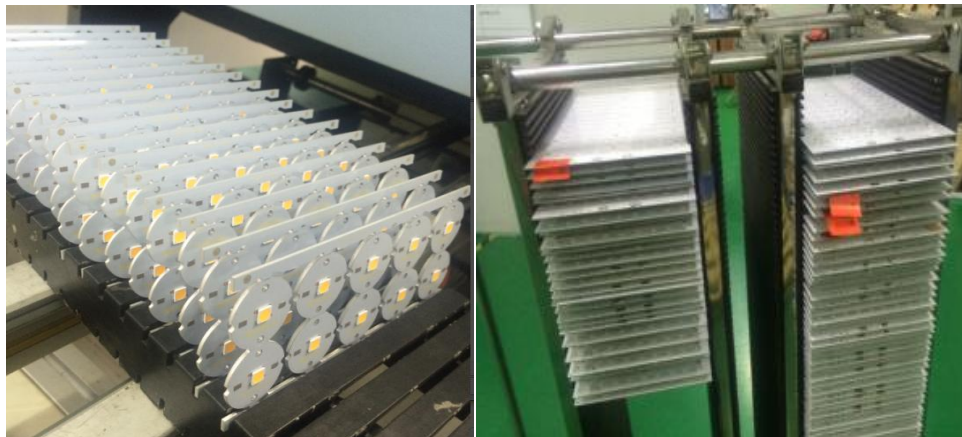

[EMC LED placement after reflow]